

93 - 08

libreria / bookcase  
HORM / Carlo Cumini, 2008  
» [catalog #02](#)

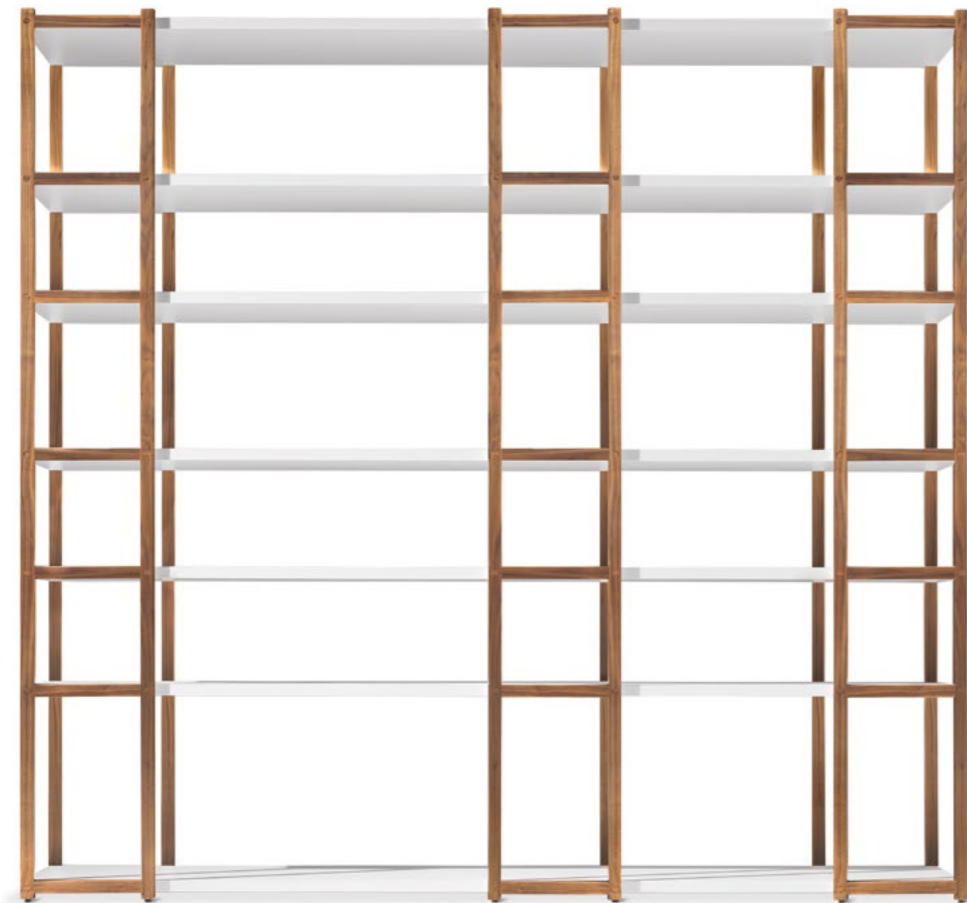

93 - 08

Carlo Cumini / 2008

  
HORM

Cad models  
Catalogues  
Warranty terms  
Assembly instructions  
Product sheet  
Technical sheet



www.horm.it

NEED  
HELP?Call us:  
+39 0434 1979**DESCRIZIONE:**

I montanti sono posizionati a coppie (un elemento davanti ed uno dietro rispetto al ripiano), e fissati ai ripiani mediante viti. I fori per le viti sono nascosti da un cerchietto in massello di noce che si aggancia alla testa della vite mediante una calamita per facilitarne l'eventuale smontaggio. I ripiani sono un pezzo unico fino ad un massimo di 290cm.

**MATERIALI:**

Montanti in noce  
canaletto massello.  
Ripiani in mdf laccato.  
Piedini regolabili

**MODULI PER LA  
COMPONIBILITA':**

[A] Vani con montanti  
- 32cm  
- 58cm  
[B] Vani aperti, tra un  
montante e l'altro:  
- 26cm  
- 52cm  
- 64cm  
- 80cm  
- 128cm (per TV max 42")  
- [C] montante finale,  
da utilizzare solo se la  
libreria termina con un  
vano aperto.

**DESCRIPTION:**

The uprights are positioned in pairs (one element in front of and one behind the shelf), and fixed to the shelves with screws. The holes for the screws are hidden by a solid walnut cap which is attached to the head of the waist by means of a magnet to make it easier to dismantle the bookcase. The shelves are a single piece up to a maximum of 290cm.

**MATERIALS:**

Uprights in solid walnut.  
Shelves in lacquered  
mdf.  
Adjustable feet

**MODULES FOR  
MODULARITY:**

[A] Compartments with  
uprights  
- 32cm  
- 58cm  
[B] Open compartments,  
between one upright and  
the next:  
- 26cm  
- 52cm  
- 64cm  
- 80cm  
- 128cm (for TV max 42")  
- [C] Final upright, to be  
used only if the library  
ends with an open  
compartment.

**DESCRIPTION :**

Les montants sont positionnés par paires (un élément devant et un derrière l'étagère) et fixés aux étagères à l'aide de vis. Les trous pour les vis sont cachés par un capuchon en noyer massif qui est fixée à la tête de la taille à l'aide d'un aimant pour faciliter le démontage éventuel. Les étagères sont d'une seule pièce jusqu'à un maximum de 290cm.

**MATÉRIAUX :**

Montants en noyer  
massif.  
Étagères en mdf laqué.  
Pieds réglables

**MODULES POUR LA  
MODULARITÉ :**

[A] Compartiments avec  
montants  
- 32cm  
- 58cm  
[B] Compartiments  
ouverts, entre un montant  
et l'autre :  
- 26cm  
- 52cm  
- 64cm  
- 80cm  
- 128cm (pour TV max  
42")  
[C] Montant final, à  
utiliser uniquement si la  
bibliothèque se termine  
par un compartiment  
ouvert.

**BESCHREIBUNG:**

Pfosten werden paarweise positioniert (ein Element vor und hinter dem Regal) und mit Schrauben an den Regalen befestigt; Löcher für Schrauben werden durch eine massive Nussbaumkappe mittels eines Magneten verdeckt, um deren eventuelle Demontage zu erleichtern. Die Regale sind einteilig bis maximal 290cm.

**MATERIALEN:**

Pfosten aus massivem  
Kanalnussbaum.  
Regale aus lackiertem  
MDF. Verstellbare Füße

**MODULE ZUR  
ZUSAMMENSTELLUNG  
DER BIBLIOTHEK:**

[A] Fächer mit Pfosten  
- 32cm  
- 58cm  
[B] Offene Fächer  
zwischen den Ständern:  
- 26cm  
- 52cm  
- 64cm  
- 80cm  
- 128cm (TV max 42")  
[C] Endpfosten, nur zu  
verwenden, wenn das  
Bücherregal mit einem  
offenen Fach endet.

**DESCRIPCION:**

Los montantes son posicionados en pares (un elemento delante y uno detrás respecto a la repisa), fijados con tornillos, cuyos foros están escondidos por un botón en nogal macizo magnético para facilitar un posible desmontaje. Las repisas son una pieza única hasta un máximo de 290 cm.

**MATERIALES:**

Montantes en nogal  
macizo. Estantes en MDF  
lacado. Pies regulables

**MÓDULOS PARA  
COMPONER LA  
BIBLIOTECA:**

[A] Compartimientos con  
montantes  
- 32cm  
- 58cm  
[B] Compartimientos  
abiertos, entre  
montantes:  
- 26cm  
- 52cm  
- 64cm  
- 80cm  
- 128cm (para TV max  
42")  
[C] montante final  
que se utiliza si la  
librería termina con un  
compartimento abierto.

**ESEMPIO #01**

Come comporre una libreria:

**EXAMPLE #01**

How to compose a library:

**EXEMPLE #01**

Comment composer une bibliothèque :

**BEISPIEL #01**

Wie man ein Bücherregal zusammenstellt:

**EJEMPLO #01**

Cómo componer una librería:

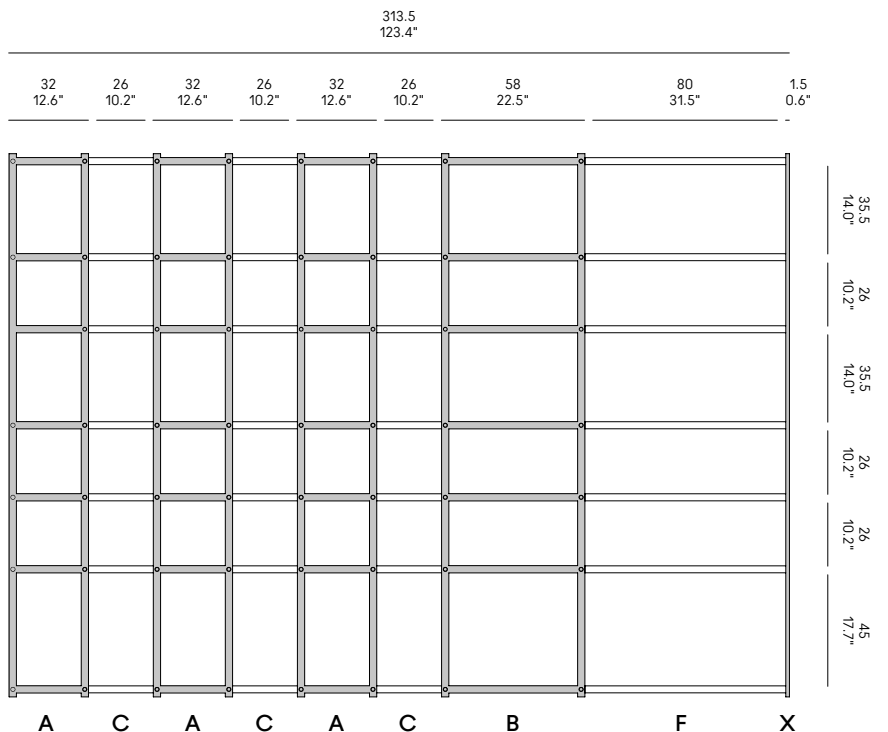

La libreria sopra rappresentata è composta dai seguenti elementi:

The library above is composed by the following elements:

La bibliothèque dessus et fait des éléments suivants:

Das Bücherregal oben besteht aus folgenden Elementen:

La librería de arriba está compuesta por los siguientes elementos:

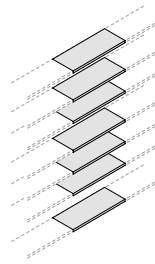
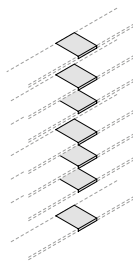
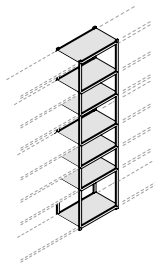
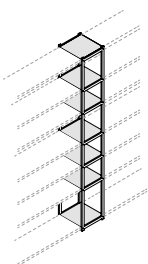

[A] x 3  
L. cm 32

[B] x 1  
L. cm 58

[C] x 3  
L. cm 26

[F] x 1  
L. cm 80

[X] x 1

Vano con montanti

Vano con montanti

Vano aperto

Vano aperto

Montante finale

Compartment with uprights.

Compartment with uprights.

Open compartment

Open compartment

Final upright.

Compartment avec montants

Compartment avec montants

Compartment ouvert

Compartment ouvert

Montant final

Fächer mit Pfosten

Fächer mit Pfosten

Offenes Fach

Offenes Fach

Endpfosten

Compartimento con montantes

Compartimento con montantes

Compartimento abierto

Compartimento abierto

Montante final

93 - 08

**ESEMPIO #02**

Come comporre una libreria:

**EXAMPLE #02**

How to compose a library:

**EXEMPLE #02**

Comment composer une bibliothèque :

**BEISPIEL #02**

Wie man ein Bücherregal zusammenstellt:

**EJEMPLO #02**

Cómo componer una librería:

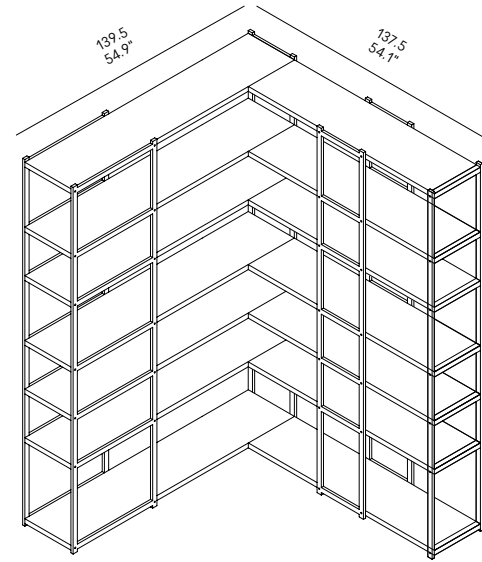
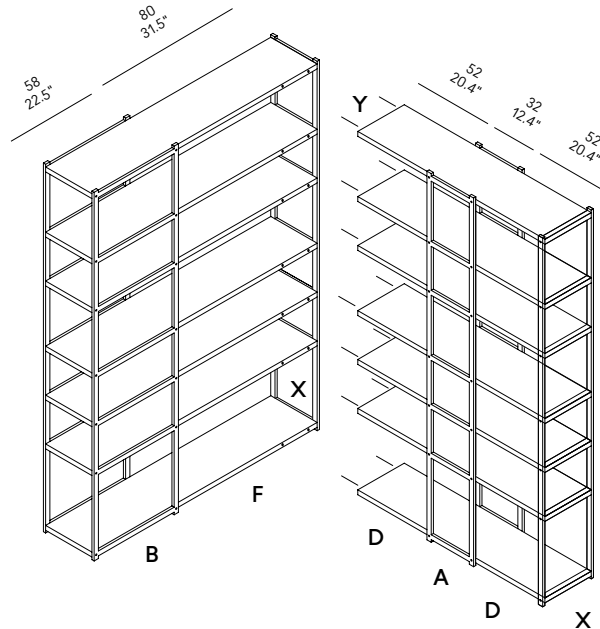

La libreria sopra rappresentata è composta dai seguenti elementi:

The library above is composed by the following elements:

La bibliothèque dessus et fait des éléments suivants:

Das Bücherregal oben besteht aus folgenden Elementen:

La librería de arriba está compuesta por los siguientes elementos:

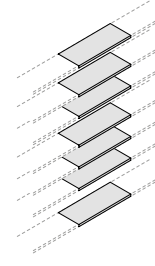
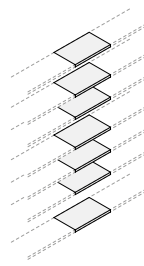
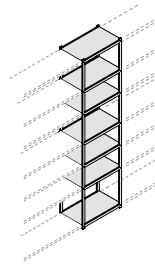
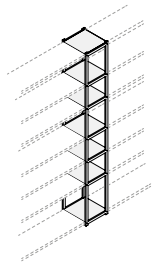

[A] x 1  
L. cm 32

[B] x 1  
L. cm 58

[D] x 2  
L. cm 52H

[F] x 1  
L. cm 80

[X] x 2

[Y] x 1

Vano con montanti

Vano con montanti

Vano aperto

Vano aperto

Montante finale

Giunzione

Compartment with uprights.

Compartment with uprights.

Open compartment

Open compartment

Final upright.

Joint

Compartment avec montants

Compartment avec montants

Compartment ouvert

Compartment ouvert

Montant final

Jonction

Fächer mit Pfosten

Fächer mit Pfosten

Offenes Fach

Offenes Fach

Endpfosten

Verbindung

Compartimiento con montantes

Compartimiento con montantes

Compartimiento abierto

Compartimiento abierto

Montante final

Junta

L › LUCIDO  
O › OPACO

L › GLOSSY  
O › MATT

L › BRILLANTE  
O › MAT

L › GLÄNZEND  
O › MATT

L › BRILLANTE  
O › OPACO

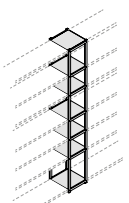
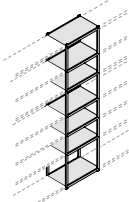
[A] VANO CON MONTANTI COMPARTMENT WITH UPRIGHTS COMPARTIMENT AVEC MONTANTS FÄCHER MIT PFOSTEN COMPARTIMIENTO CON MONTANTES	Nero Black Noir Schwarz Negro RAL 9011	Bianco White Blanc Weiß Blanco RAL 9016	Polvere Dusty grey Gris poussière Staubgrau Gris polvo RAL 7037	Beige Beige grey Gris beige Beigegräu Gris beige RAL 7006	Rosso vino Wine red Rouge vin Weinrot Rojo vino RAL 3005	Bruno Brown grey Gris brun Braungräu Gris parduzco RAL 7013	Grafite Graphite Graphite Graphit Grafito RAL 7024	
 <b>A</b> cm 32 x 34.5 x 218H 12.4" x 13.6" x 85.9"H	L	KX03-R9011L	KX03400L	KX03-R7037L	KX03-R7006L	KX03-R3005L	KX03-R7013L	KX03-R7024L
	O	KX03-R9011	KX03400	KX03-R7037	KX03-R7006	KX03-R3005	KX03-R7013	KX03-R7024
 <b>B</b> cm 58 x 34.5 x 218H 22.5" x 13.6" x 85.9"H	L	KX05-R9011L	KX05400L	KX05-R7037L	KX05-R7006L	KX05-R3005L	KX05-R7013L	KX05-R7024L
	O	KX05-R9011	KX05400	KX05-R7037	KX05-R7006	KX05-R3005	KX05-R7013	KX05-R7024

MONTANTE FINALE  
FINAL UPRIGHT  
MONTANT FINAL  
ENDPFOSTEN  
MONTANTE FINAL



**X**  
cm 31.5 x 1.5 x 218H  
12.4" x 0.5" x 85.9"H

KX00000

Y

GIUNZIONE  
JOINT  
JONCTION  
VERBINDUNG  
JUNTA

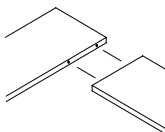

KBL1000

Z

TAGLIO SU MISURA  
CUSTOM-CUT  
COUPE SUR MESURE  
ZUSCHNITT AUF MASS  
CORTE A MEDIDA

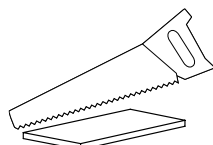

KBL2000

93 - 08

L › LUCIDO  
O › OPACOL › GLOSSY  
O › MATTL › BRILLANTE  
O › MATL › GLÄNZEND  
O › MATTL › BRILLANTE  
O › OPACO

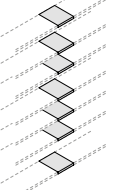
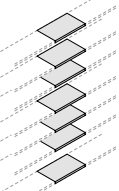
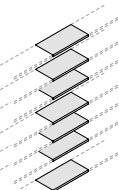
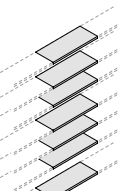
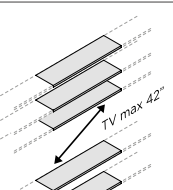
		Nero Black Noir Schwarz Negro RAL 9011	Bianco White Blanc Weiß Blanco RAL 9016	Polvere Dusty grey Gris poussière Staubgrau Gris polvo RAL 7037	Beige Beige grey Gris beige Beigegrau Gris beige RAL 7006	Rosso vino Wine red Rouge vin Weinrot Rojo vino RAL 3005	Bruno Brown grey Gris brun Braungrau Gris parduzco RAL 7013	Grafite Graphite Graphite Graphit Grafito RAL 7024
<b>[B]</b> VANO APERTO OPEN COMPARTMENT COMPARTIMENT OUVERT OFFENES FACH COMPARTIMIENTO ABIERTO								
	L	KB02-R9011L	KB02000L	KB02-R7037L	KB02-R7006L	KB02-R3005L	KB02-R7013L	KB02-R7024L
<b>C</b> cm 26 x 31.5 x 218H 10.2" x 12.4" x 85.9"H	O	KB02-R9011	KB02000	KB02-R7037	KB02-R7006	KB02-R3005	KB02-R7013	KB02-R7024
	L	KB05-R9011L	KB05000L	KB05-R7037L	KB05-R7006L	KB05-R3005L	KB05-R7013L	KB05-R7024L
<b>D</b> cm 52 x 31.5 x 218H 20.4" x 12.4" x 85.9"H	O	KB05-R9011	KB05000	KB05-R7037	KB05-R7006	KB05-R3005	KB05-R7013	KB05-R7024
	L	KB06-R9011L	KB06000L	KB06-R7037L	KB06-R7006L	KB06-R3005L	KB06-R7013L	KB06-R7024L
<b>E</b> cm 64 x 31.5 x 218H 25.2" x 12.4" x 85.9"H	O	KB06-R9011	KB06000	KB06-R7037	KB06-R7006	KB06-R3005	KB06-R7013	KB06-R7024
	L	KB08-R9011L	KB08000L	KB08-R7037L	KB08-R7006L	KB08-R3005L	KB08-R7013L	KB08-R7024L
<b>F</b> cm 80 x 31.5 x 218H 31.5" x 12.4" x 85.9"H	O	KB08-R9011	KB08000	KB08-R7037	KB08-R7006	KB08-R3005	KB08-R7013	KB08-R7024
	L	KB12-R9011L	KB12000L	KB12-R7037L	KB12-R7006L	KB12-R3005L	KB12-R7013L	KB12-R7024L
<b>G</b> Vano TV / TV compartment								
cm 128 x 31.5 x 218H 50.4" x 12.4" x 85.9"H	O	KB12-R9011	KB12000	KB12-R7037	KB12-R7006	KB12-R3005	KB12-R7013	KB12-R7024

604 [Delivery terms: EX-FACTORY ITALY]

List Price / Manufacturer's Suggested Retail Price / Recommended Retail Price  
IVA esclusa / VAT and other Taxes excluded / Hors taxes / Ohne MwSt / IVA a parte

L › LUCIDO  
O › OPACO

L › GLOSSY  
O › MATT

L › BRILLANTE  
O › MAT

L › GLÄNZEND  
O › MATT

L › BRILLANTE  
O › OPACO

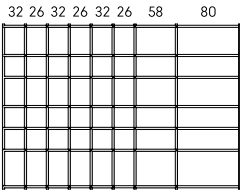
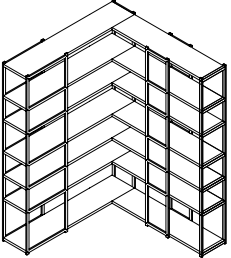
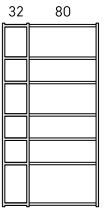
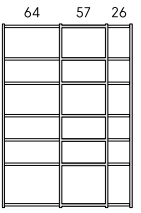
ESEMPLI DI COMPOSIZIONE EXAMPLE OF COMPOSITIONS EXEMPLES DE COMPOSITIONS BEISPIELE VON KOMPOSITIONEN EJEMPLOS DE COMPOSICIONES	Nero Black Noir Schwarz Negro RAL 9011	Bianco White Blanc Weiß Blanco RAL 9016	Polvere Dusty grey Gris poussière Staubgrau Gris polvo RAL 7037	Beige Beige grey Gris beige Beigegrau Gris beige RAL 7006	Rosso vino Wine red Rouge vin Weinrot Rojo vino RAL 3005	Bruno Brown grey Gris brun Braungrau Gris parduzco RAL 7013	Grafite Graphite Graphite Graphit Grafito RAL 7024
 <p><b>EXAMPLE #01</b></p> <p>cm 32 x 34.5 x 218H 12.4" x 13.6" x 85.9"H</p>							
 <p><b>EXAMPLE #02</b></p> <p>cm 123 x 34.5 x 218H 48.6" x 13.6" x 85.9"H</p>							
 <p><b>EXAMPLE #03</b></p> <p>cm 113 x 34.5 x 218H 44.5" x 13.6" x 85.9"H</p>							
 <p><b>EXAMPLE #04</b></p> <p>cm 150 x 34.5 x 218H 59.1" x 13.6" x 85.9"H</p>							

L › LUCIDO  
O › OPACO

L › GLOSSY  
O › MATT

L › BRILLANTE  
O › MAT

L › GLÄNZEND  
O › MATT

L › BRILLANTE  
O › OPACO

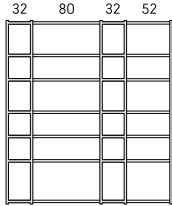
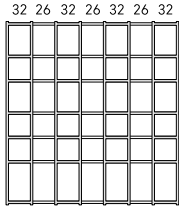
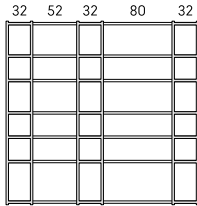
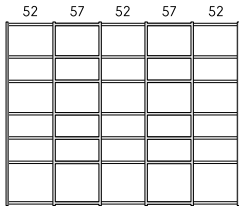
ESEMPI DI COMPOSIZIONE EXAMPLE OF COMPOSITIONS EXEMPLES DE COMPOSITIONS BEISPIELE VON KOMPOSITIONEN EJEMPLOS DE COMPOSICIONES		Nero Black Noir Schwarz Negro RAL 9011	Bianco White Blanc Weiß Blanco RAL 9016	Polvere Dusty grey Gris poussière Staubgrau Gris polvo RAL 7037	Beige Beige grey Gris beige Beigegrau Gris beige RAL 7006	Rosso vino Wine red Rouge vin Weinrot Rojo vino RAL 3005	Bruno Brown grey Gris brun Braungrau Gris parduzco RAL 7013	Grafite Graphite Graphite Graphit Grafito RAL 7024
 <p><b>EXAMPLE #05</b></p> <p>cm 197 x 34.5 x 218H 77.6" x 13.6" x 85.9"H</p>	L							
	O							
 <p><b>EXAMPLE #06</b></p> <p>cm 205 x 34.5 x 218H 80.8" x 13.6" x 85.9"H</p>	L							
	O							
 <p><b>EXAMPLE #07</b></p> <p>cm 227 x 34.5 x 218H 89.4" x 13.6" x 85.9"H</p>	L							
	O							
 <p><b>EXAMPLE #08</b></p> <p>cm 274 x 34.5 x 218H 108" x 13.6" x 85.9"H</p>	L							
	O							



L › LUCIDO  
O › OPACO

L › GLOSSY  
O › MATT

L › BRILLANTE  
O › MAT

L › GLÄNZEND  
O › MATT

L › BRILLANTE  
O › OPACO

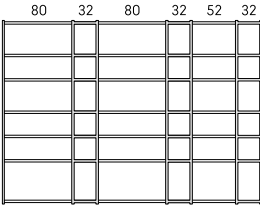
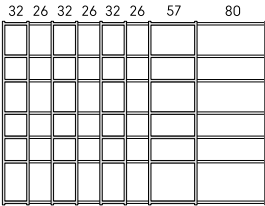
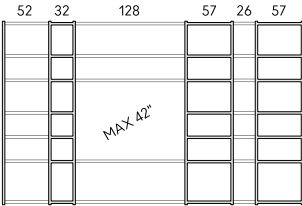
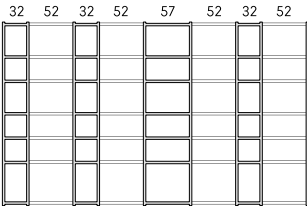
ESEMPLI DI COMPOSIZIONE EXAMPLE OF COMPOSITIONS EXEMPLES DE COMPOSITIONS BEISPIELE VON KOMPOSITIONEN EJEMPLOS DE COMPOSICIONES	Nero Black Noir Schwarz Negro RAL 9011	Bianco White Blanc Weiß Blanco RAL 9016	Polvere Dusty grey Gris poussière Staubgrau Gris polvo RAL 7037	Beige Beige grey Gris beige Beigegräu Gris beige RAL 7006	Rosso vino Wine red Rouge vin Weinrot Rojo vino RAL 3005	Bruno Brown grey Gris brun Braungräu Gris parduzco RAL 7013	Grafite Graphite Graphite Graphit Grafito RAL 7024
 <p><b>EXAMPLE #09</b></p> <p>cm 309 x 34.5 x 218H 121.7" x 13.6" x 85.9"H</p>	L						
	O						
 <p><b>EXAMPLE #10</b></p> <p>cm 312 x 34.5 x 218H 123.0" x 13.6" x 85.9"H</p>	L						
	O						
 <p><b>EXAMPLE #11</b></p> <p>cm 353 x 34.5 x 218H 139.0" x 13.6" x 85.9"H</p>	L						
	O						
 <p><b>EXAMPLE #12</b></p> <p>cm 361 x 34.5 x 218H 142.1" x 13.6" x 85.9"H</p>	L						
	O						